

LTG0,1/22

Conductivity Cell with temperature sensor

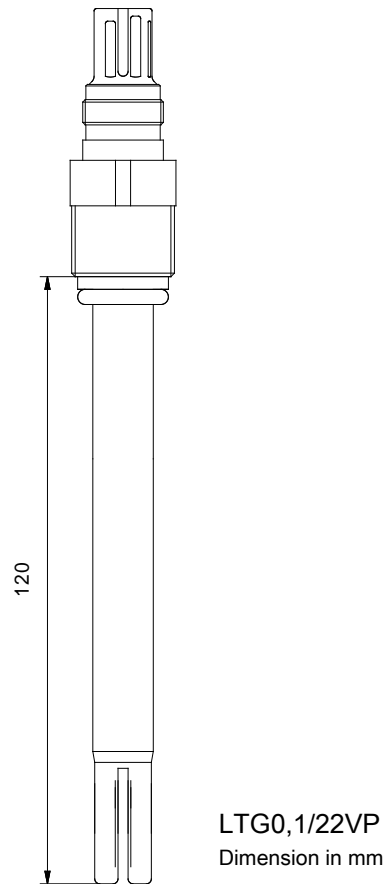

The conductivity sensor LTG0,1/23 combines enhanced 2-electrode technology with rugged design in a 12 mm glass body and an incorporated temperature probe is available. The LTG0,1/23 features a low measuring range, low maintenance and easy cleaning, ideal for universal application, even in partly aqueous and highly aggressive media as well as in pure water.

In addition to the version with Variopin plug head system and separated cable connection, models with fixed cable are available.

Sensor shaft	glass, Ø 12 mm
Immersion length	120 mm
Electrode material	platinum
Temperature range	-5...100 °C
Temperature probe	Pt100 for automatic temperature compensation and temperature measurement
Measuring range	0.1...200 µS/cm (dependent from frequency and measuring voltage)
Cell constant	0.1 cm ⁻¹ ± 20 %
Minimum immersion depth	35 mm
Pressure	< 6 bar
Storage	within the protective cap filled with distilled water
Electrical connection	<ul style="list-style-type: none"> ▪ Variopin plug head with thread PG 13.5 ▪ fixed cable
Process connection	<ul style="list-style-type: none"> ▪ with the relevant configuration thread PG 13.5 at sensor head for direct mounting in housings

- Electrical connections of the sensor:
 - LTG0,1/22VP: Variopin plug head with thread PG 13.5; separate connection cable is required
 - LTG0,1/22-K050-F-P: 5 m fixed cable, stripped ends, thread PG 13.5
 - LTG0,1/22...: standard model LTG0,1/22 (plug head; cable length [1 m, 2 m, 5 m, 10 m], special cable length, plug, thread PG 13.5 are available)
 - LTG0,1/22 (OEM): customer specially designed models (sensor length, OEM logo, ...)
- Accompanying plug head cable connections:
 - KVP/3: coaxial cable, length 3 m with Variopin socket, without meter plug